



# HTTC 86100

# HTT 86100

**100 U.S. ton | 85 metric ton Hydraulic Truck Crane**  
**100 U.S. ton | 85 metric ton Truck Terrain Crane**

- **38-140 ft (11.6-42.7 m) five-section, latching boom** with no charted capacity deductions for telescoping loads.
- **35-58 ft (10.7-17.7 m) two-piece, bi-fold, on-board lattice attachment** with 2°, 15°, 30°, 45° offsets - optional
- **Two 16 ft (4.9 m) lattice inserts** provide a total attachment length of 90 ft (27.4 m) - optional
- **237 ft (72.2 m) maximum tip height**
- Modular style counterweights
- **16,880 lbs (7 656.6 kg) maximum winch line pull**
- **480 fpm (146.3 m/min) maximum winch line speed**
- **Next generation operator's cab** with improved visibility and ergonomics
- **Automated Manual Transmission**
- **Front and rear air ride suspension**
- **Anti-lock (ABS) brakes**
- **Four lockable storage boxes**
- **"Stow 'n Go" steel pontoons**



# HTT HTG 86100

100 U.S. ton | 85 metric ton  
Hydraulic Truck Crane

100 U.S. ton | 85 metric ton  
Truck Terrain Crane

## Outstanding mobility on the road and on the job site

- 38-140 ft | 11.6 - 42.7 m 5-section pin & latch boom with attachment flexibility
  - 35-58 ft | 10.7-17.7 m two-piece, bi-fold, on-board lattice attachment with 2°, 15°, 30°, 45° offsets - optional
  - Optional - Two 16 ft | 4.9 m lattice inserts provide a total attachment length of 90 ft | 27.4 m
  - 237 ft | 72.2 m maximum tip height
- Big, wide cab with outstanding visibility
- Winches deliver impressive numbers of line pull and line speed
  - 16,880 lbs | 75.0 kN maximum winch line pull
  - 480 fpm | 143 m/min maximum winch line speed
- Counterweight flexibility, big engine and transmission power, along with air-ride promise incredible mobility on the road or on the job

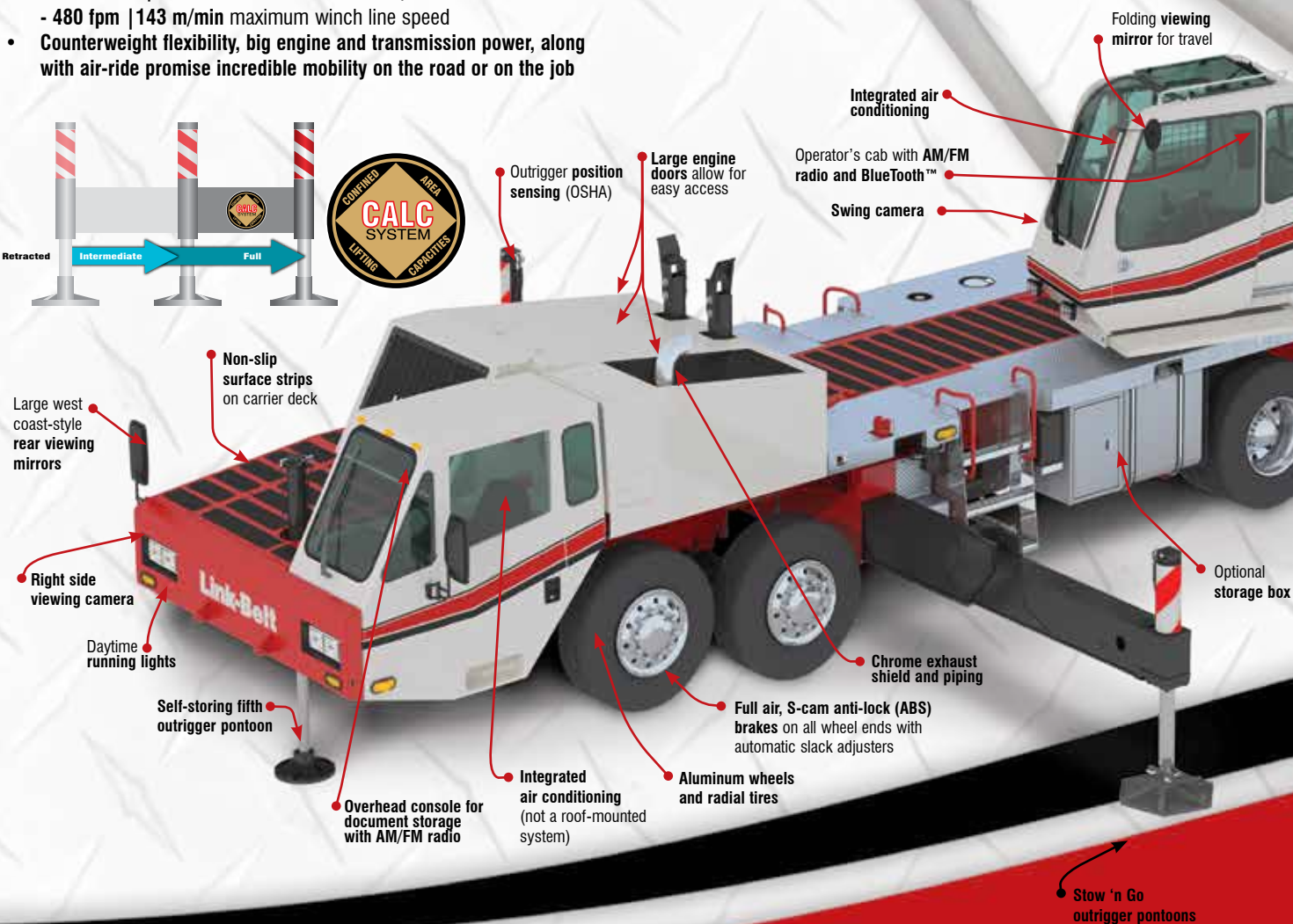
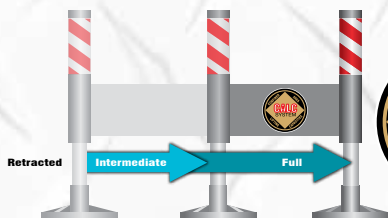

Stow 'n Go outrigger pontoons





## Powerful and responsive hydraulics

- Six pump, pressure compensated hydraulic system allows simultaneous and precise function of boom hoist, winch and swing.
- Two-speed hydraulic piston motor system delivers superior hoisting. Matched size optional front and rear winches provide equal max line pulls of 16,880 lbs (75.0 kn) and max line speeds of 480 fpm (143 m/min) on 16" (.41 m) root diameter grooved drums.
- Drum rotation indicators - standard.
- Bi-directional hydraulic swing motor mounted to a planetary reduction unit for 360° swing. Spring applied hydraulic released 360° swing park brake provides infinite swing park positions as well as free swing when control is in a neutral position



# HTT

## Designed for amazing job-site maneuverability

Steerable all wheel axles, in conjunction with super single tires, makes the HTT even harder to beat on the job-site, and NO changes to the on-outrigger capacity charts.

- Drive and steer capabilities for the rear axles
- Four steering modes: Independent front, Independent rear, All wheel, Diagonal
- Rear axles self-center and lock in the straight ahead position for high speed travel
- Turning radius under 29 ft (8.8 m) at the edge of the tire
- 445/65R22.5 tires front and rear that are interchangeable
- Only one spare rim and tire combination is needed
- Transverse (cross-axle) differential locks that greatly improve traction on unimproved job-site conditions.

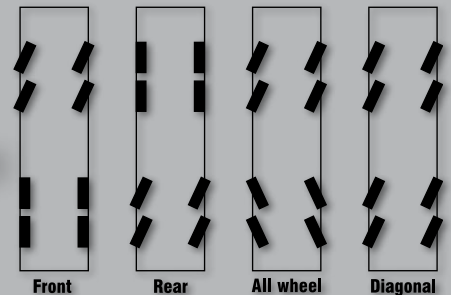
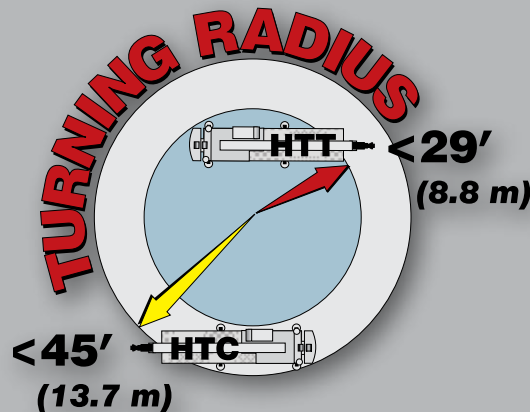

Carrier-mounted outtrigger controls, located on each side of the carrier, include an engine throttle-up switch for fast outtrigger deployment. For fine level adjusting of the carrier, throttle can be taken down to idle.

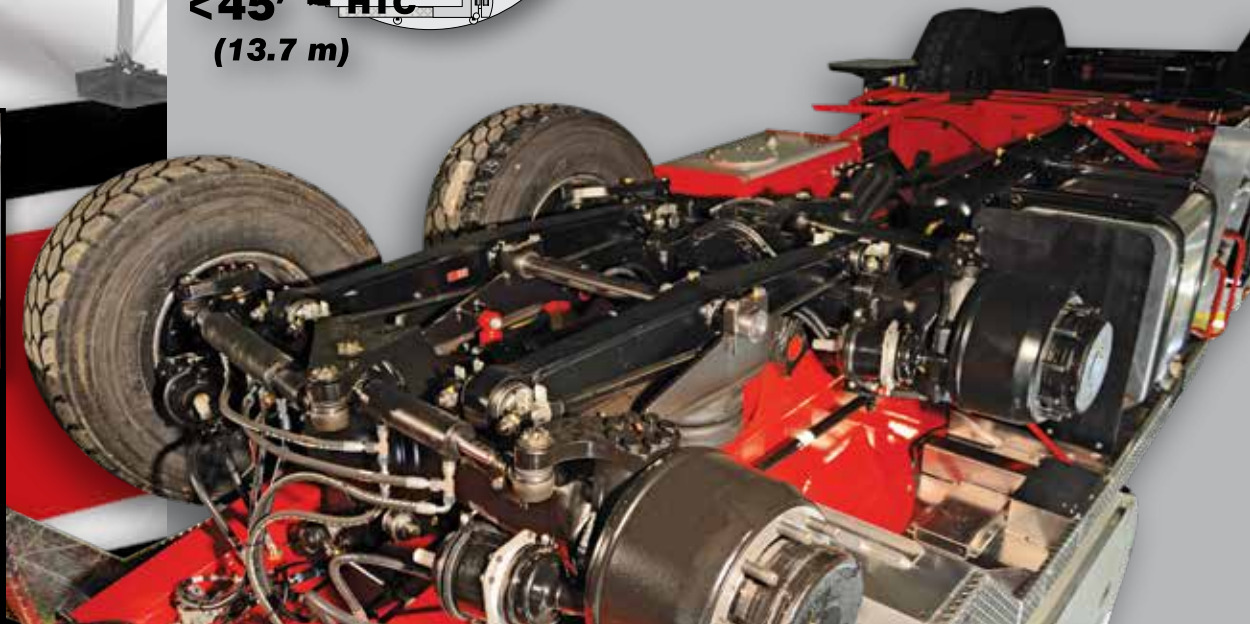



# Link-Belt PULSE

## Total crane operating system

**Link-Belt Pulse** is the Link-Belt designed total crane operating system. It includes the rated capacity limiter, boom extend mode controller (EMC), self-diagnostic capabilities and continuous monitoring of multiple crane functions and conditions. To aid operators in a safe and efficient operation, its high-resolution, color-intense graphic display provides excellent contrast even in direct sunlight.



Single axis controller

Dual axis controller



Rated capacity limited light bar



Standard - internal



Optional - external

## Operator's cab provides ergonomic comfort and control

### Roomier and quieter operator's cab

- **Extra large windows** throughout for excellent visibility
- **Excellent ventilation** via a large sliding door, side and rear windows, and hinged roof window
- **Single or dual axis, hydraulic operated controller** mounted on armrest for outstanding operator comfort
- **6-way adjustable power tilting seat**
- All gauges, switches, indicators, and controls are located in the **operator's forward line of sight**
- All gauges and switches are backlit for **excellent visibility in low light conditions**
- **Winch and right side swing view cameras**
- In cab comfort is maintained by the **standard heater and air conditioning**

## Telematics. You own the data!

Cellular-based data logging and monitoring system that provides:

- Viewing options for sharing data with distributor and Link-Belt
- Location and operational settings
- Monitor routine maintenance intervals
- Crane and engine monitoring
- Diagnostic and fault codes



# Multiple counterweight configurations give you capacities for any size job

- **Standard** - total of 11,500 lbs | 5.2 mt (A,B,C) of removable counterweights. Capacities for **five** different counterweight configurations.
- **Optional** - up to 39,500 lbs | 17.9 mt (A,B,C,C,D,E,F,G) of removable counterweights. Capacities for up to thirteen different counterweight configurations.
- All configurations can be raised and lowered by hydraulic cylinders from the comfort of the operator's cab for ease of installation and removal.

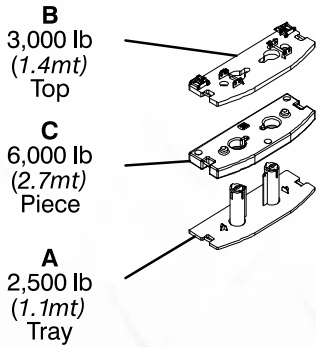

**Standard - 11,500 lb (5.2mt)**

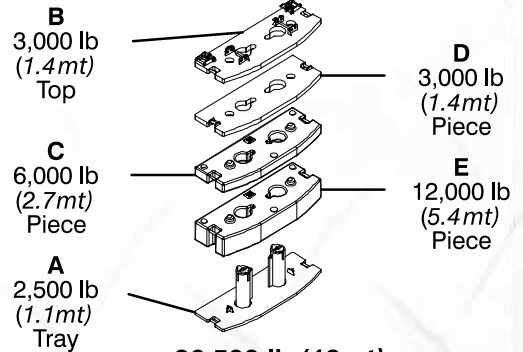

**26,500 lb (12mt)**

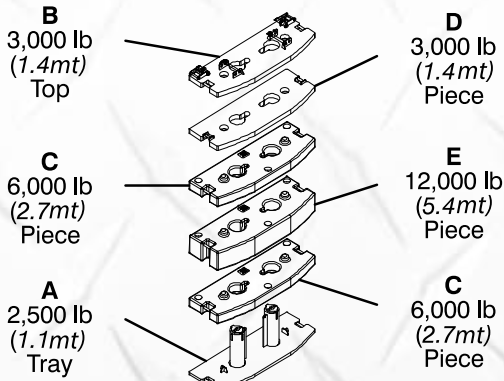

**32,500 lb (14.7mt)**

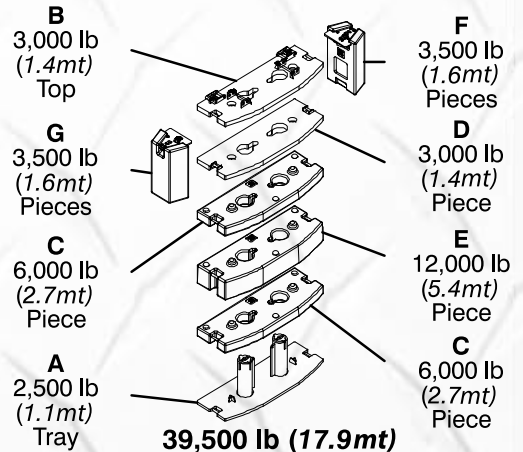

**39,500 lb (17.9mt)**



**Standard—11,500 lb | 5.2 mt**



**Optional—39,500 lb | 17.9 mt**

All counterweight configurations can be raised and lowered by hydraulic cylinders from the comfort of the operator's cab for ease of installation and removal.



## Counterweight Configurations

		17,500 lb   7.9 mt	A,B,C,C
0		20,500 lb   9.3 mt	A,B,C,C,D
2,500 lb   1.1 mt	A	23,500 lb   10.6 mt	A,B,C,E
5,500 lb   2.5 mt	A,B	26,500 lb   12 mt	A,B,C,D,E
8,500 lb   3.8 mt	A,C	<b>29,500 lb   13.3 mt</b>	<b>A,B,C,C,E</b>
<b>11,500 lb   5.2 mt</b>	<b>A,B,C</b>	32,500 lb   14.7 mt	A,B,C,C,D,E
14,500 lb   6.6 mt	A,B,C,D	39,500 lb   17.9 mt	A,B,C,C,D,E,F,G



Wind speed indicator

# Superior capacities and extension ranges

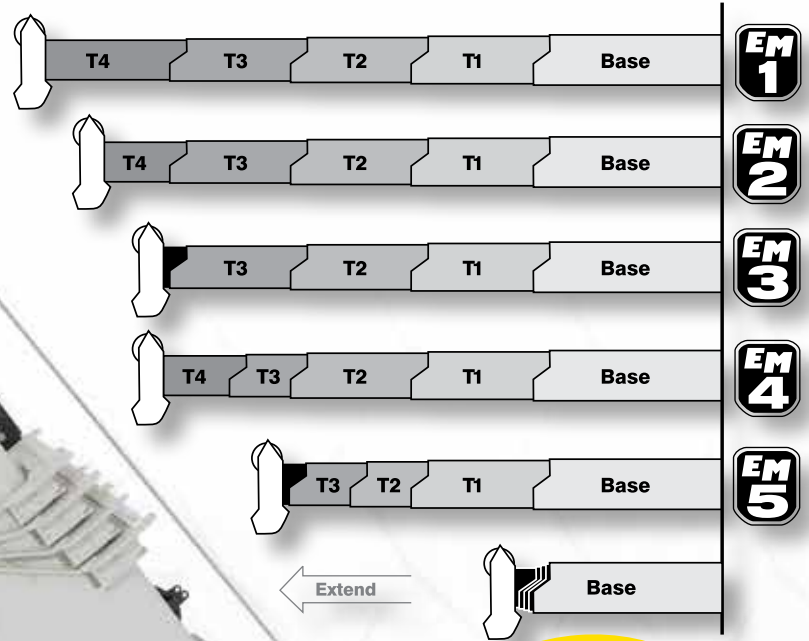

**Only 5  
Extend  
Modes!**

Standard boom dolly connections

# Jobsite proven for over 15 years!

Mechanical boom angle indicator - standard



Optional: 35-58 ft (10.7-17.7 m) two-piece bi-fold, lattice attachment with 2°, 15°, 30°, and 45° offsets

# The only greaseless, high-capacity formed booms designed and built in North America!

- **Teflon pucks** lubricate the boom
- **Greater life span** than greased wear pads
- **Easy to adjust**

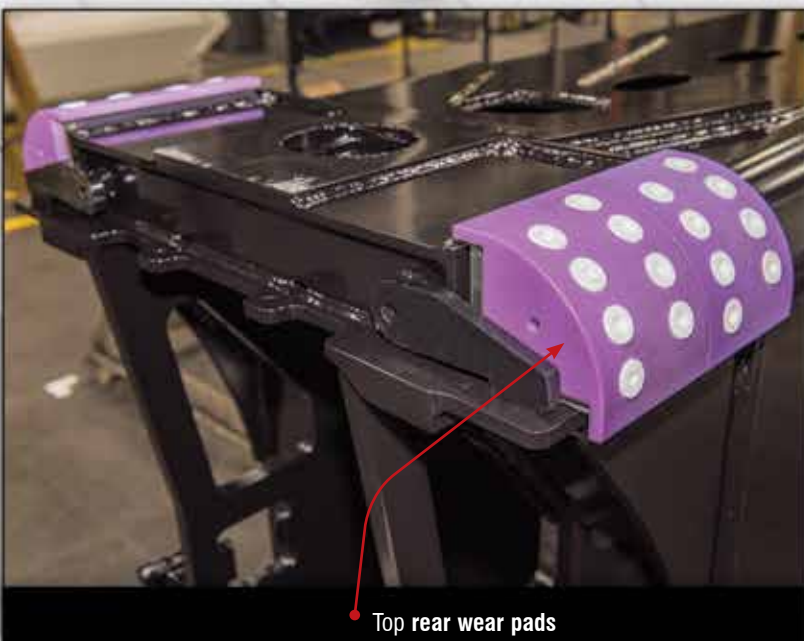

Quick reeve boom head eliminates the need to remove the becket when it becomes necessary to change the reeving

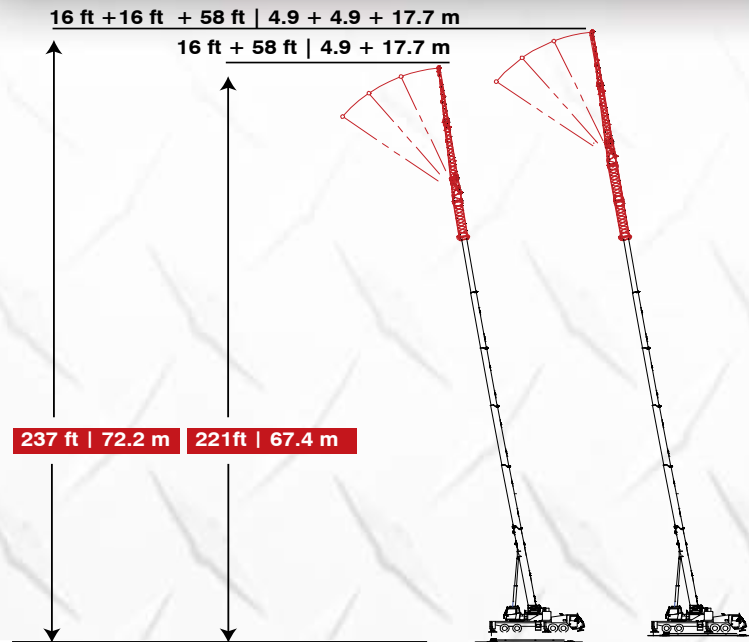

### Tip-Heights – Optional Lattice Fly Extension

The optional 58 ft | 17.7 m two piece offsettable bi-fold fly can be extended by adding up to two optional 16 ft | 4.9 m lattice inserts with 2°, 15°, 30°, and 45° manual offsets.

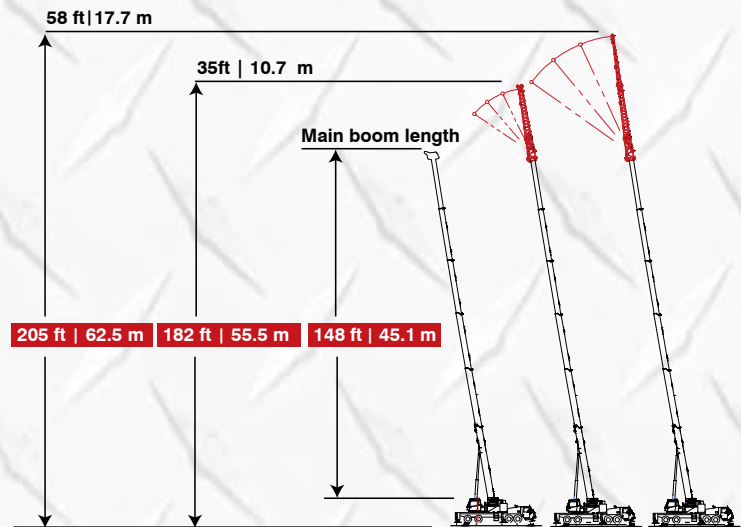

### Tip-Heights – Optional On-board Lattice Fly

35 – 58 ft | 10.7 – 17.7 m two piece, bi-fold, on-board lattice attachment with 2°, 15°, 30°, and 45° manual offsets.



# Superior accessibility



The **pull-out CabWalk™** slides out from its secured travel position underneath the operator's cab to give the operator a platform to stand on for easy entry and exit from the cab.



The upper work platform with **folding handrails** allows for easy inspection and **maintenance** of the HTC-86100.

Access to the operator's cab and engine compartment is superb with **strategically located ladders and steps**.

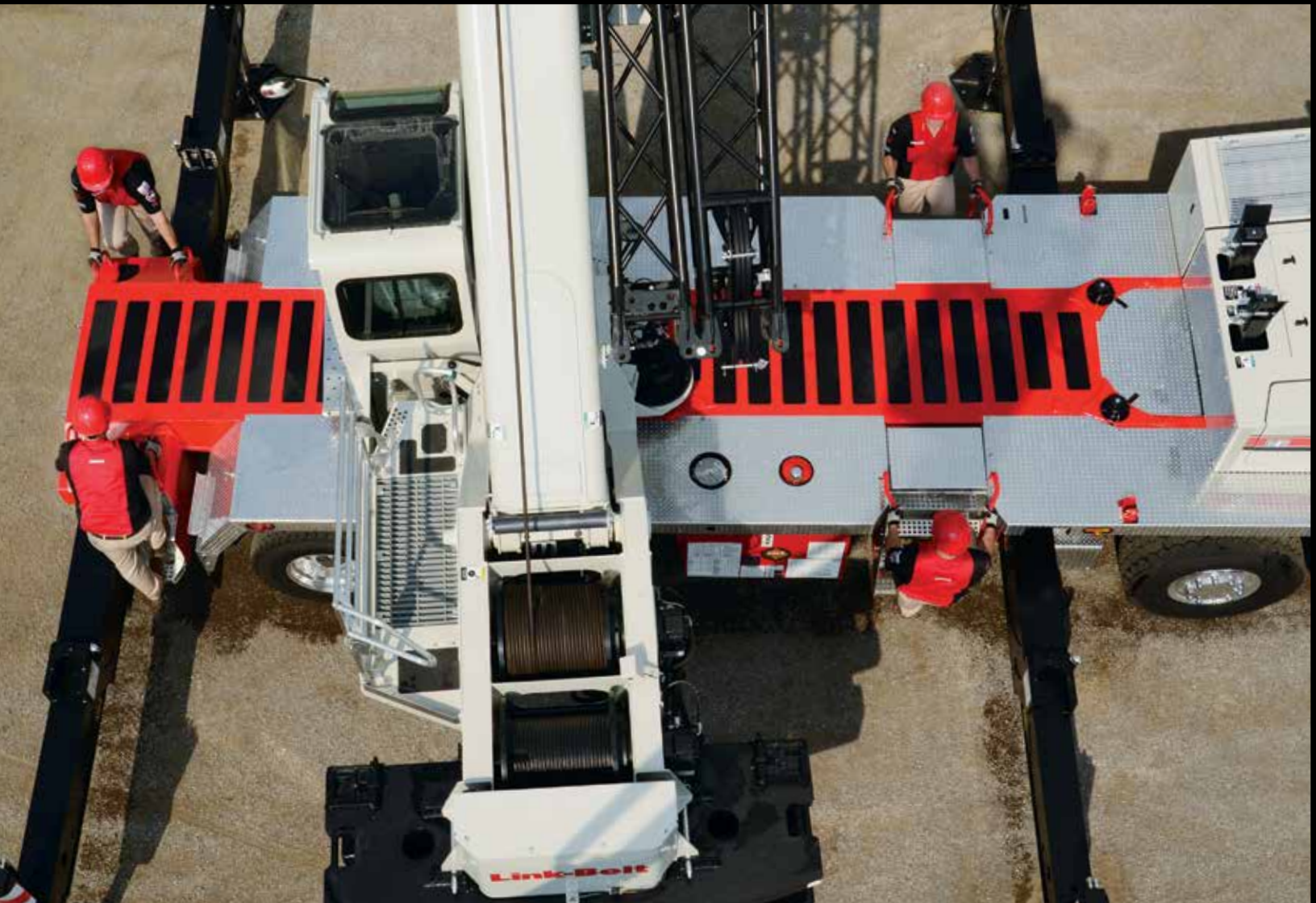



# See what you've been missing – onboard cameras!



Operator cab monitor



Carrier cab monitor



Swing viewing camera



Right side viewing camera



Winch viewing camera



Rear viewing camera



Optional - boom dolly camera\*

\*Supplied by Dolly manufacturer

OPERATOR CAB CAMERAS

CARRIER CAB CAMERAS



# Road and job site ready!



- **Automated transmission** (no clutch pedal) —12 speeds forward, 2 speeds reverse with two modes of operation: **fully automatic and semi-automatic**
- Job site travel is **permissible with counterweight** for exceptional job site versatility.
- **Boom dolly/trailer ready** when equipped with optional boom float kit, rear electrical and air connections.
- **Cruise control**
- Engine **compression brake**
- Ether injection system—**optional**



Optional rear electrical and air connections



- **Air-ride suspension** front and rear provides a smooth ride and precise handling. Optional air-ride **lift system** holds the rear suspension retracted while the crane is on outriggers.



- **Comfortable carrier cab:**
- Dash-mounted **comprehensive instrumentation** with back-lit gauge
- Roll up/down door window provides **excellent ventilation**
- Fully adjustable **air-ride fabric seat**
- **Suspended pedals**

## Storage compartments

- There are **two standard locking storage boxes** with options up to four boxes

Right side storage and ladder



Right side fender storage





# Work light package available

Lighting packages and flood lights available



Single boom flood light



Dual boom floodlight & high intensity remote controlled floodlight



Single boom flood light



Cab mounted work lights

# Illuminated compartments and controls for night-time operation

Outrigger keypad box

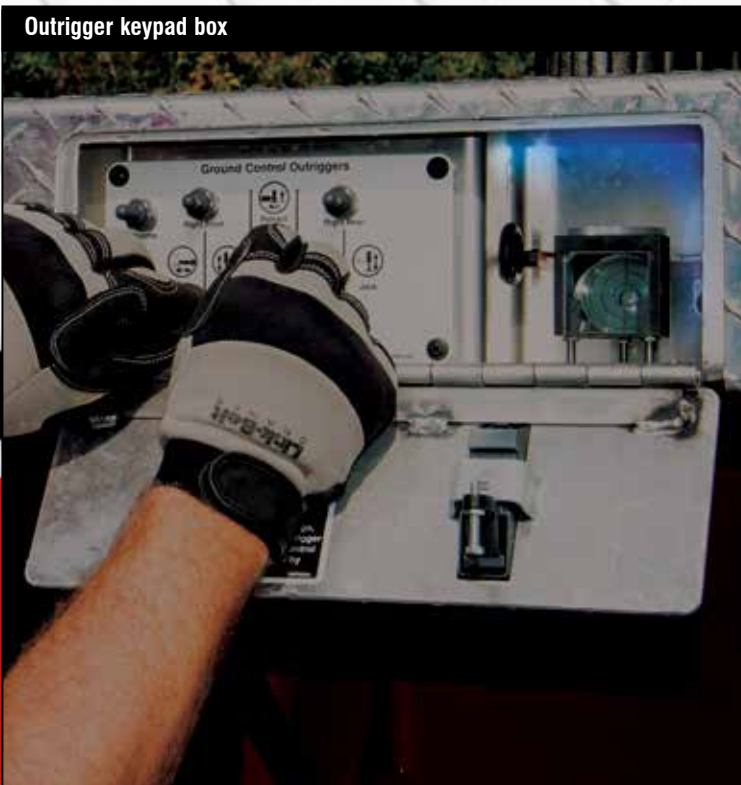

Illuminated right front fender storage







Link-Belt Construction Equipment Company is a leader in the design, manufacture and sales of telescopic and lattice boom cranes with headquarters and manufacturing facilities in Lexington, Kentucky, USA. Link-Belt is committed to the manufacture and service of high quality products that satisfy customers worldwide.

Towards that end, Link-Belt has pursued a strategy of growth and investment. It has moved aggressively to seize more global market share by producing a broader range of products and strengthening distribution and personnel around the globe.

Link-Belt is also home to a family of passionate professionals with a legacy of innovation and cutting-edge technology spanning over 140 years. These professionals, in a 770,800 sq. ft. (71 609 m<sup>2</sup>) manufacturing facility and with a culture of continuous innovation, have pushed Link-Belt to be the most modern crane manufacturer in North America.

**Your crane investment is always protected... with your Link-Belt distributor.**

When you invest in a Link-Belt crane, you invest in a legacy of outstanding customer support dating back to 1874. The ultimate value of a machine begins with state-of-the-art design and quality manufacturing, but it is the excellent Link-Belt distributor product support that determines its long term value. This philosophy has earned Link-Belt cranes the enviable position of traditionally commanding some of the highest resale prices in the industry.

"... to be recognized as a **leader** in **customer service & satisfaction.**"  
—The Link-Belt Vision

**Link-Belt Preferred**

As a member of Link-Belt Cranes user's group, you will have access to:

- A comprehensive online library of parts, service & operator manuals for YOUR crane
- Interactive, live groundbearing calculations for YOUR crane
- 3D lift planning
- Online access to recommended spare parts lists, filter, lube and key lists plus maintenance information and more
- No annual fee or charges to access your crane information
- Factory-trained distributor support
- Experienced factory technicians
- 24/7 parts distribution with 95% availability
- Factory parts customer service reps
- Link-Belt certified structural repair
- Boom inspection
- Plus a vast array of information on new products, services and special offerings

**Online 3D LIFT PLANNING**

- Web-based, active 3D, high graphic
- User-friendly, no CAD program required
- Always current, no updates required
- Print actual lift



**Online GROUNDBEARING PRESSURES**

- Dynamic specific machine model proton loadings
- Graphically illustrated in 360° numerical presentation
- Print out

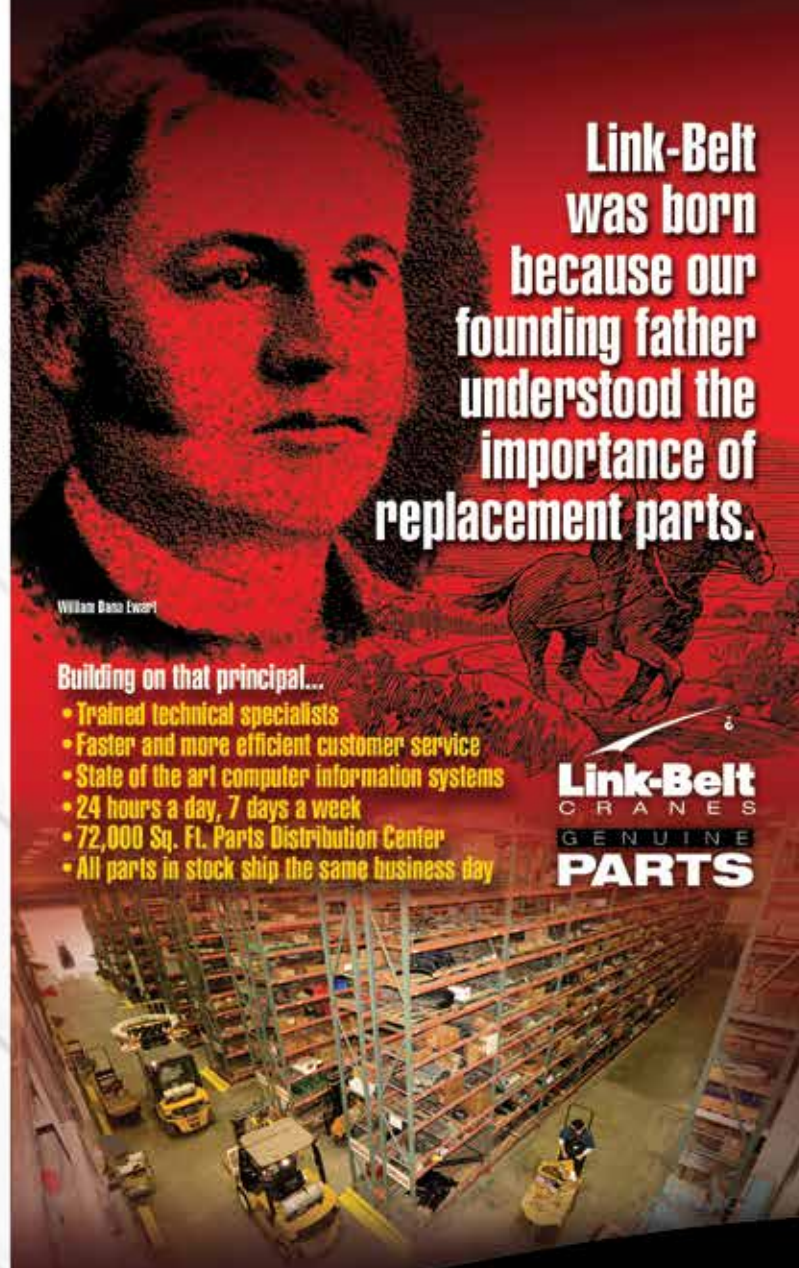

**Link-Belt was born because our founding father understood the importance of replacement parts.**

William Bano Exner

**Building on that principal...**

- Trained technical specialists
- Faster and more efficient customer service
- State of the art computer information systems
- 24 hours a day, 7 days a week
- 72,000 Sq. Ft. Parts Distribution Center
- All parts in stock ship the same business day

**Link-Belt CRANES GENUINE PARTS**

©Link-Belt is a registered trademark. Copyright 2019 All rights reserved. We reserve the right to change designs and specifications at any time. Litho in U.S.A. 9/19 3642 #4570 (supersedes #4563)

**Link-Belt CRANES**  
Lexington, Kentucky | www.linkbelt.com